

# IRF9910

HEXFET® Power MOSFET

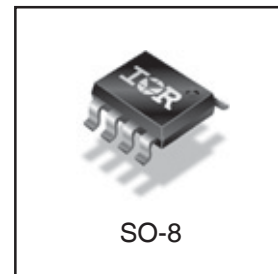
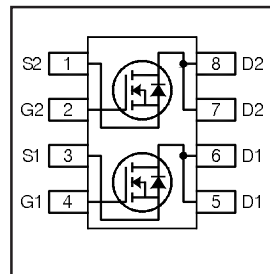
## Applications

- Dual SO-8 MOSFET for POL converters in desktop, servers, graphics cards, game consoles and set-top box

$V_{DSS}$	$R_{DS(on)}$ max	$I_D$
20V	Q1 13.4mΩ @ $V_{GS} = 10V$	10A
	Q2 9.3mΩ @ $V_{GS} = 10V$	12A

## Benefits

- Very Low  $R_{DS(on)}$  at 4.5V  $V_{GS}$
- Low Gate Charge
- Fully Characterized Avalanche Voltage and Current
- 20V  $V_{GS}$  Max. Gate Rating



## Absolute Maximum Ratings

	Parameter	Q1 Max.	Q2 Max.	Units
$V_{DS}$	Drain-to-Source Voltage	20		V
$V_{GS}$	Gate-to-Source Voltage	± 20		
$I_D @ T_A = 25^\circ C$	Continuous Drain Current, $V_{GS} @ 10V$	10	12	A
$I_D @ T_A = 70^\circ C$	Continuous Drain Current, $V_{GS} @ 10V$	8.3	9.9	
$I_{DM}$	Pulsed Drain Current ①	83	98	
$P_D @ T_A = 25^\circ C$	Power Dissipation	2.0		W
$P_D @ T_A = 70^\circ C$	Power Dissipation	1.3		
	Linear Derating Factor	0.016		W/°C
$T_J$	Operating Junction and	-55 to + 150		°C
$T_{STG}$	Storage Temperature Range			

## Thermal Resistance

	Parameter	Typ.	Max.	Units
$R_{\theta JL}$	Junction-to-Drain Lead	—	20	°C/W
$R_{\theta JA}$	Junction-to-Ambient ④⑤	—	62.5	

Notes ① through ⑤ are on page 10

www.irf.com

# IRF9910

International  
**IR** Rectifier

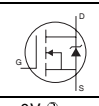
Static @  $T_J = 25^\circ\text{C}$  (unless otherwise specified)

	Parameter		Min.	Typ.	Max.	Units	Conditions
$BV_{DSS}$	Drain-to-Source Breakdown Voltage	Q1&Q2	20	---	---	V	$V_{GS} = 0V, I_D = 250\mu A$
$\Delta BV_{DSS}/\Delta T_J$	Breakdown Voltage Temp. Coefficient	Q1	---	0.0061	---	V/ $^\circ\text{C}$	Reference to $25^\circ\text{C}, I_D = 1\text{mA}$
		Q2	---	0.014	---		
$R_{DS(on)}$	Static Drain-to-Source On-Resistance	Q1	---	10.7	13.4	m $\Omega$	$V_{GS} = 10V, I_D = 10A$ ①
			---	14.6	18.3		$V_{GS} = 4.5V, I_D = 8.3A$ ③
		Q2	---	7.4	9.3		$V_{GS} = 10V, I_D = 12A$ ③
			---	9.1	11.3		$V_{GS} = 4.5V, I_D = 9.8A$ ③
$V_{GS(th)}$	Gate Threshold Voltage	Q1&Q2	1.65	---	2.55	V	$V_{DS} = V_{GS}, I_D = 250\mu A$
$\Delta V_{GS(th)}/\Delta T_J$	Gate Threshold Voltage Coefficient	Q1	---	-4.9	---	mV/ $^\circ\text{C}$	
		Q2	---	-5.0	---		
$I_{BSS}$	Drain-to-Source Leakage Current	Q1&Q2	---	---	1.0	$\mu A$	$V_{DS} = 16V, V_{GS} = 0V$
		Q1&Q2	---	---	100		$V_{DS} = 16V, V_{GS} = 0V, T_J = 125^\circ\text{C}$
$I_{GSS}$	Gate-to-Source Forward Leakage	Q1&Q2	---	---	100	nA	$V_{GS} = 20V$
	Gate-to-Source Reverse Leakage	Q1&Q2	---	---	-100		$V_{GS} = -20V$
gfs	Forward Transconductance	Q1	19	---	---	S	$V_{DS} = 10V, I_D = 8.3A$
		Q2	27	---	---		$V_{DS} = 10V, I_D = 9.8A$
$Q_g$	Total Gate Charge	Q1	---	7.4	11		
		Q2	---	15	23		
$Q_{gs1}$	Pre-Vth Gate-to-Source Charge	Q1	---	2.6	---	nC	Q1 $V_{DS} = 10V$ $V_{GS} = 4.5V, I_D = 8.3A$
		Q2	---	4.3	---		
$Q_{gs2}$	Post-Vth Gate-to-Source Charge	Q1	---	0.85	---		
		Q2	---	1.4	---		
$Q_{gd}$	Gate-to-Drain Charge	Q1	---	2.5	---		
		Q2	---	5.4	---		
$Q_{qodr}$	Gate Charge Overdrive	Q1	---	1.5	---		Q2 $V_{DS} = 10V$ $V_{GS} = 4.5V, I_D = 9.8A$
		Q2	---	3.9	---		
$Q_{sw}$	Switch Charge ( $Q_{gs2} + Q_{gd}$ )	Q1	---	3.4	---		
		Q2	---	6.8	---		
$Q_{oss}$	Output Charge	Q1	---	4.0	---	nC	$V_{DS} = 10V, V_{GS} = 0V$
		Q2	---	8.7	---		
$t_{d(on)}$	Turn-On Delay Time	Q1	---	6.3	---	ns	Q1 $V_{DD} = 16V, V_{GS} = 4.5V$ $I_D = 8.3A$
		Q2	---	8.3	---		
$t_r$	Rise Time	Q1	---	10	---		
		Q2	---	14	---		
$t_{d(off)}$	Turn-Off Delay Time	Q1	---	9.2	---		Q2 $V_{DD} = 16V, V_{GS} = 4.5V$ $I_D = 9.8A$ Clamped Inductive Load
		Q2	---	15	---		
$t_f$	Fall Time	Q1	---	4.5	---		
		Q2	---	7.5	---		
$C_{iss}$	Input Capacitance	Q1	---	900	---	pF	$V_{GS} = 0V$ $V_{DS} = 10V$ $f = 1.0\text{MHz}$
		Q2	---	1860	---		
$C_{oss}$	Output Capacitance	Q1	---	290	---		
		Q2	---	600	---		
$C_{rss}$	Reverse Transfer Capacitance	Q1	---	140	---		
		Q2	---	310	---		

## Avalanche Characteristics

	Parameter	Typ.	Q1 Max.	Q2 Max.	Units
$E_{AS}$	Single Pulse Avalanche Energy ②	---	33	26	mJ
$I_{AR}$	Avalanche Current ①	---	8.3	9.8	A

## Diode Characteristics

	Parameter		Min.	Typ.	Max.	Units	Conditions
$I_S$	Continuous Source Current (Body Diode)	Q1&Q2	---	---	2.5	A	MOSFET symbol showing the integral reverse p-n junction diode.
$I_{SM}$	Pulsed Source Current (Body Diode) ①	Q1	---	---	83	A	
		Q2	---	---	98		
$V_{SD}$	Diode Forward Voltage	Q1	---	---	1.0	V	$T_J = 25^\circ\text{C}, I_S = 8.3A, V_{GS} = 0V$ ③
		Q2	---	---	1.0		$T_J = 25^\circ\text{C}, I_S = 9.8A, V_{GS} = 0V$ ③
$t_{rr}$	Reverse Recovery Time	Q1	---	11	17	ns	Q1 $T_J = 25^\circ\text{C}, I_F = 8.3A,$ $V_{DD} = 10V, di/dt = 100A/\mu s$ ③
		Q2	---	16	24		
$Q_{rr}$	Reverse Recovery Charge	Q1	---	3.1	4.7	nC	Q2 $T_J = 25^\circ\text{C}, I_F = 9.8A,$ $V_{DD} = 10V, di/dt = 100A/\mu s$ ③
		Q2	---	4.9	7.3		

Q1 - Control FET

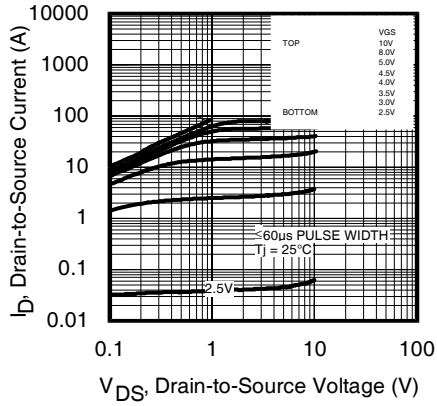


Fig 1. Typical Output Characteristics

Q2 - Synchronous FET

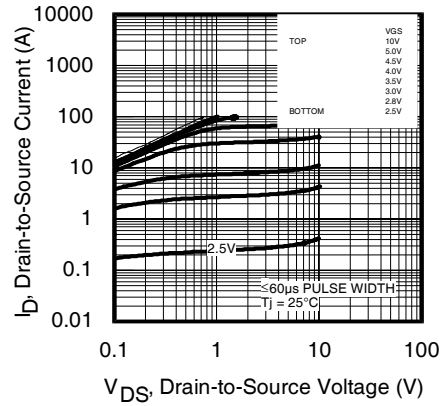


Fig 2. Typical Output Characteristics

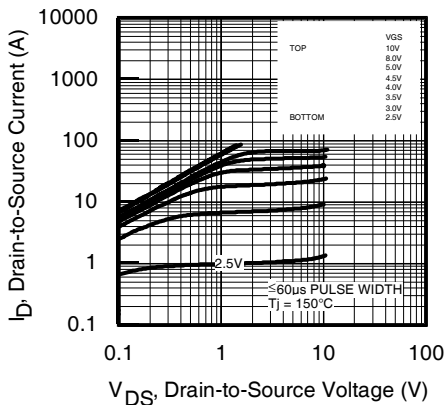


Fig 3. Typical Output Characteristics

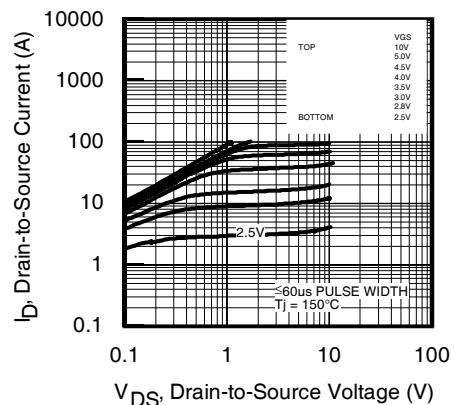


Fig 4. Typical Output Characteristics

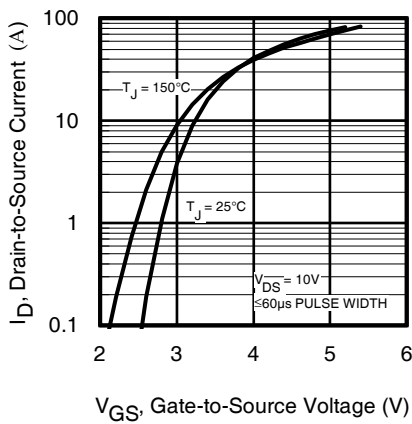


Fig 5. Typical Transfer Characteristics

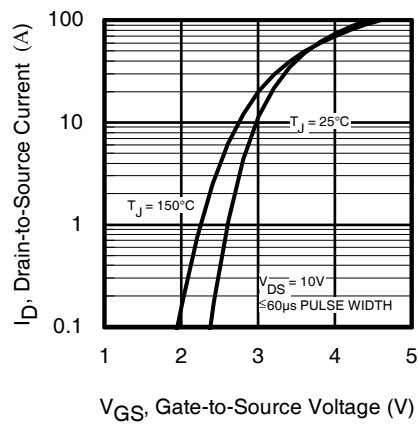


Fig 6. Typical Transfer Characteristics

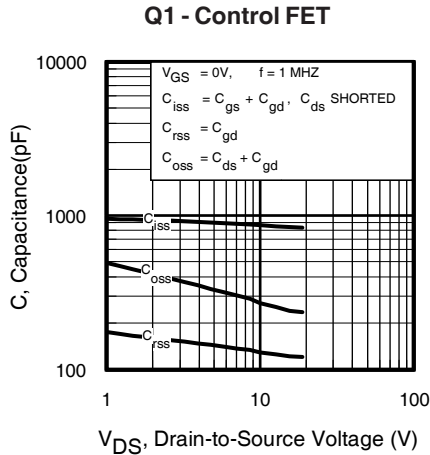


Fig 7. Typical Capacitance Vs. Drain-to-Source Voltage

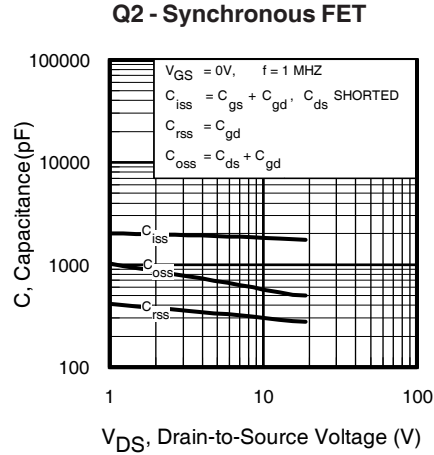


Fig 8. Typical Capacitance Vs. Drain-to-Source Voltage

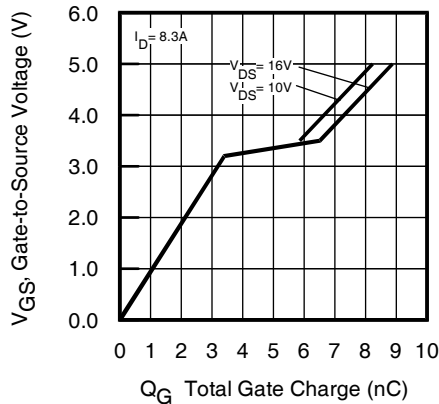


Fig 9. Gate-to-Source Voltage vs Typical Gate Charge

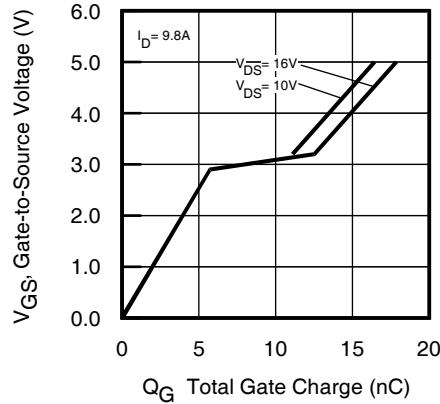


Fig 10. Gate-to-Source Voltage vs Typical Gate Charge

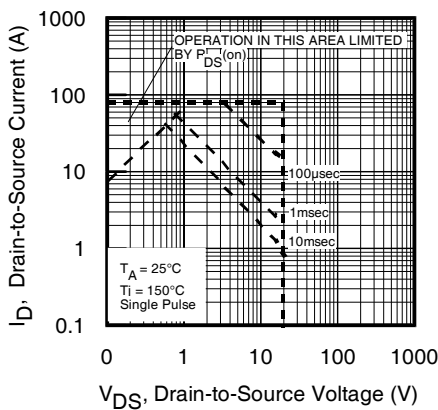


Fig 11. Maximum Safe Operating Area

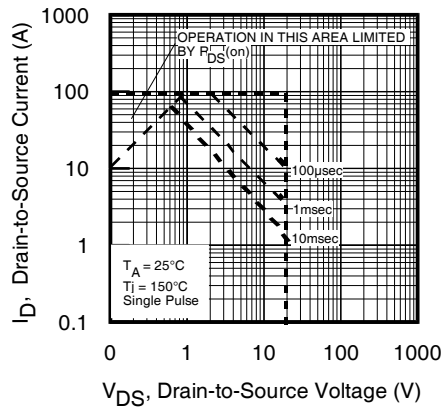


Fig 12. Maximum Safe Operating Area

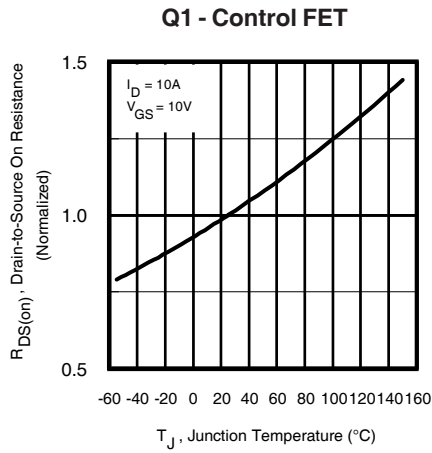


Fig 13. Normalized On-Resistance vs. Temperature

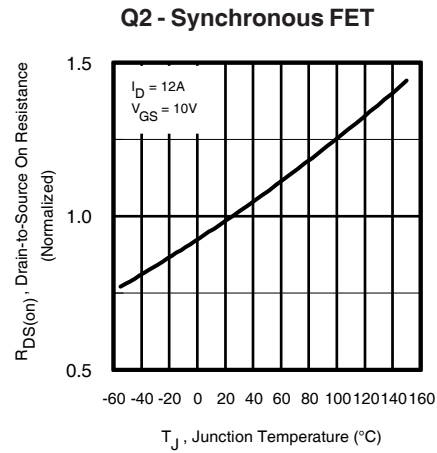


Fig 14. Normalized On-Resistance vs. Temperature

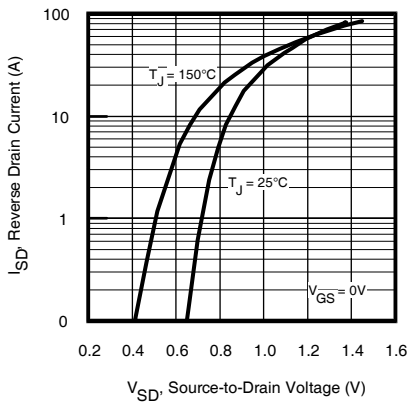


Fig 15. Typical Source-Drain Diode Forward Voltage

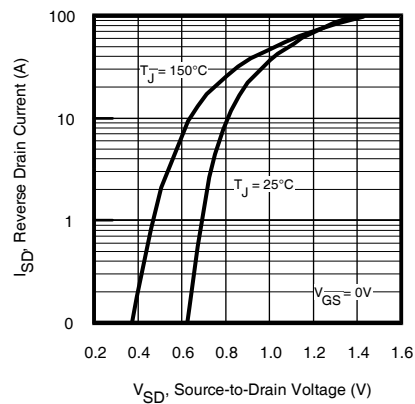


Fig 16. Typical Source-Drain Diode Forward Voltage

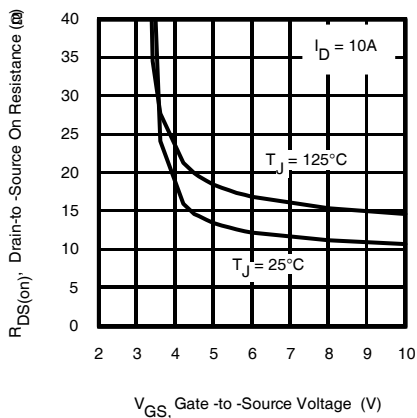


Fig 17. Typical On-Resistance vs. Gate Voltage

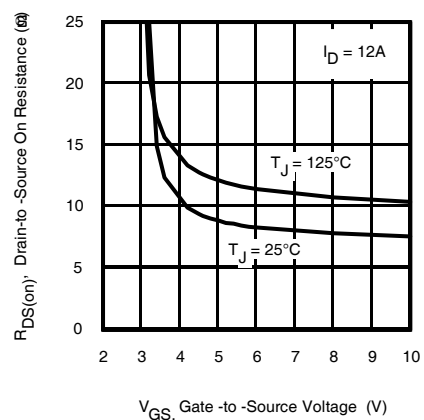
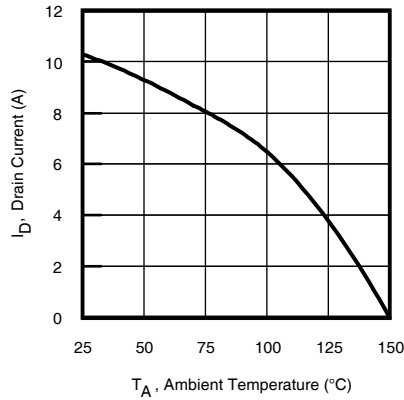


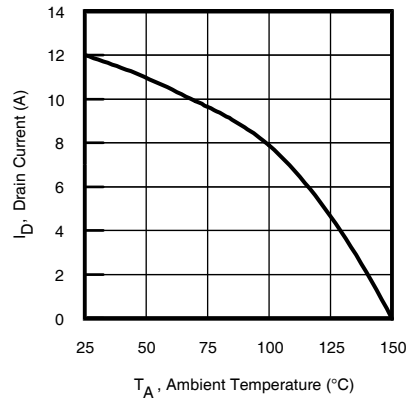
Fig 18. Typical On-Resistance vs. Gate Voltage

**Q1 - Control FET**

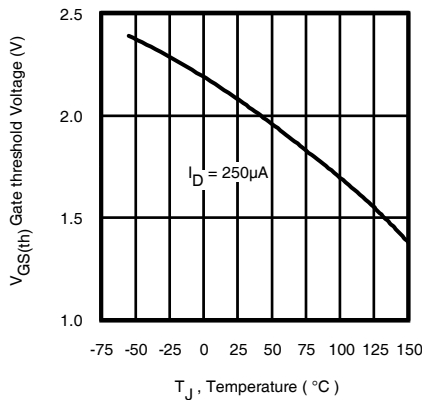


**Fig 19. Maximum Drain Current vs. Ambient Temperature**

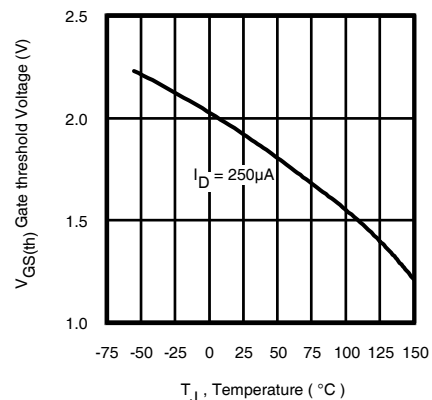
**Q2 - Synchronous FET**



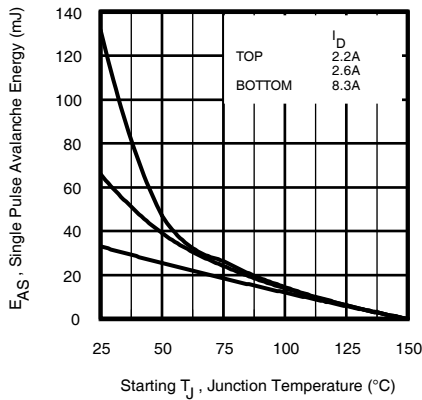
**Fig 20. Maximum Drain Current vs. Ambient Temperature**



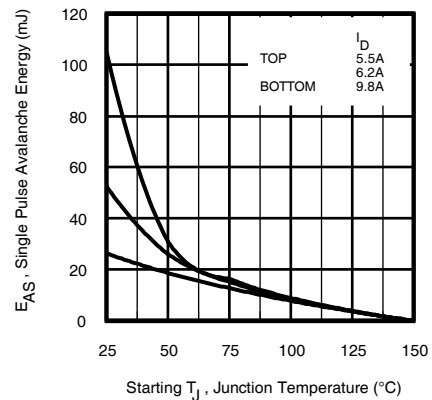
**Fig 21. Threshold Voltage vs. Temperature**



**Fig 22. Threshold Voltage vs. Temperature**



**Fig 23. Maximum Avalanche Energy vs. Drain Current**



**Fig 24. Maximum Avalanche Energy vs. Drain Current**

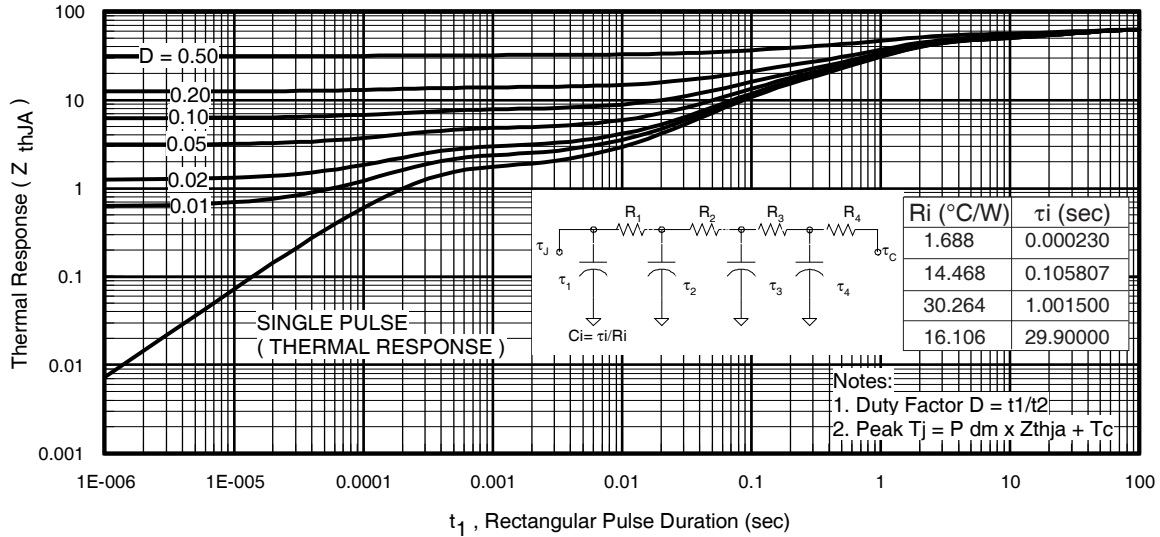


Fig 25. Maximum Effective Transient Thermal Impedance, Junction-to-Ambient

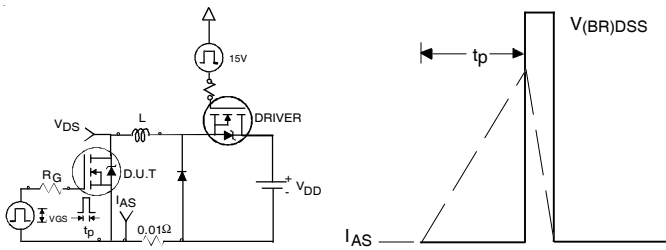


Fig 26. Unclamped Inductive Test Circuit and Waveform

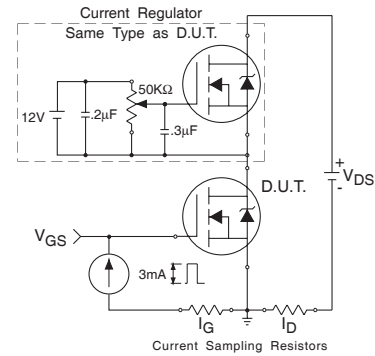


Fig 27. Gate Charge Test Circuit

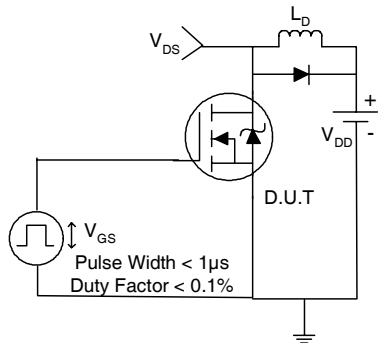


Fig 28. Switching Time Test Circuit

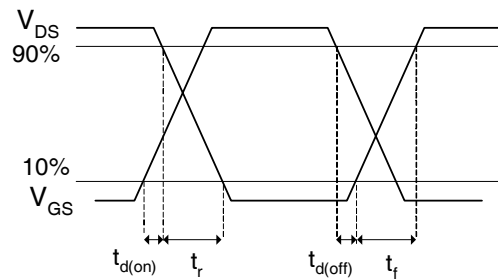
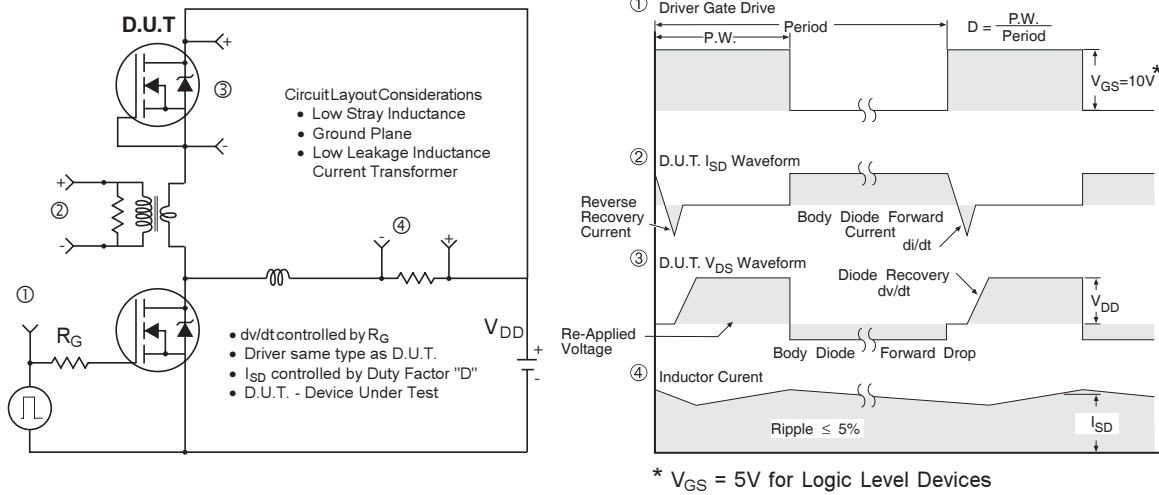
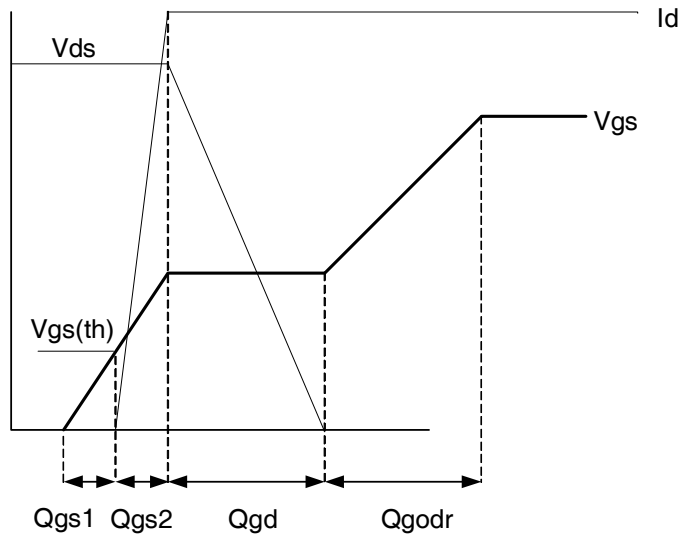


Fig 29. Switching Time Waveforms



**Fig 30. Peak Diode Recovery  $dv/dt$  Test Circuit for N-Channel HEXFET® Power MOSFETs**

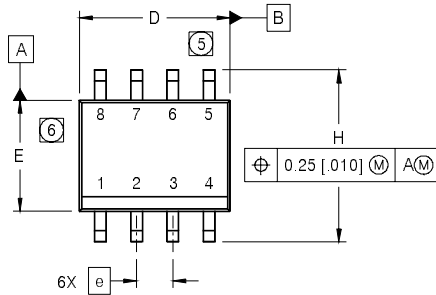


**Fig 31. Gate Charge Waveform**

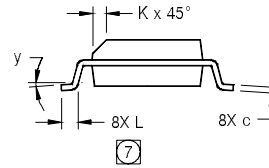
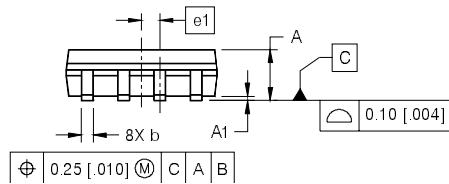


## SO-8 Package Details

Dimensions are shown in millimeters (inches)



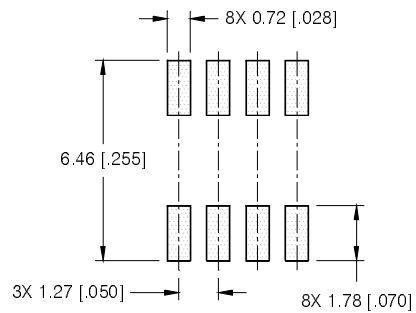
DIM	INCHES		MILLIMETERS	
	MIN	MAX	MIN	MAX
A	.0532	.0688	1.35	1.75
A1	.0040	.0098	0.10	0.25
b	.013	.020	0.33	0.51
c	.0075	.0098	0.19	0.25
D	.189	.1968	4.80	5.00
E	.1497	.1574	3.80	4.00
e	.050 BASIC		1.27 BASIC	
e1	.025 BASIC		0.635 BASIC	
H	.2284	.2440	5.80	6.20
K	.0099	.0196	0.25	0.50
L	.016	.050	0.40	1.27
y	0°	8°	0°	8°



**NOTES:**

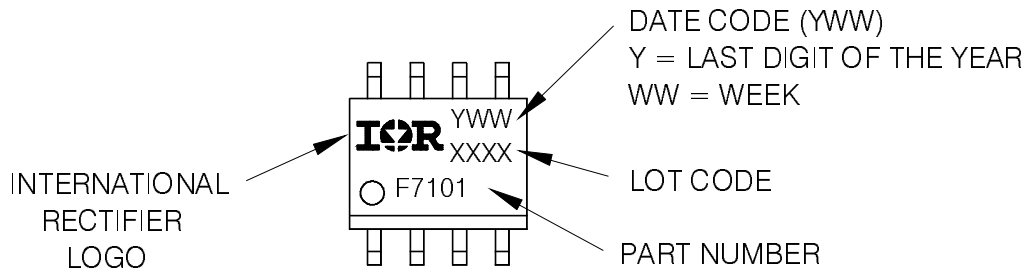
1. DIMENSIONING & TOLERANCING PER ASME Y14.5M-1994.
2. CONTROLLING DIMENSION: MILLIMETER
3. DIMENSIONS ARE SHOWN IN MILLIMETERS [INCHES].
4. OUTLINE CONFORMS TO JEDEC OUTLINE MS-012AA.
- ⑤ DIMENSION DOES NOT INCLUDE MOLD PROTRUSIONS. MOLD PROTRUSIONS NOT TO EXCEED 0.15 [0.006].
- ⑥ DIMENSION DOES NOT INCLUDE MOLD PROTRUSIONS. MOLD PROTRUSIONS NOT TO EXCEED 0.25 [0.010].
- ⑦ DIMENSION IS THE LENGTH OF LEAD FOR SOLDERING TO A SUBSTRATE.

**FOOTPRINT**



## SO-8 Part Marking

EXAMPLE: THIS IS AN IRF7101 (MOSFET)



# IRF9910

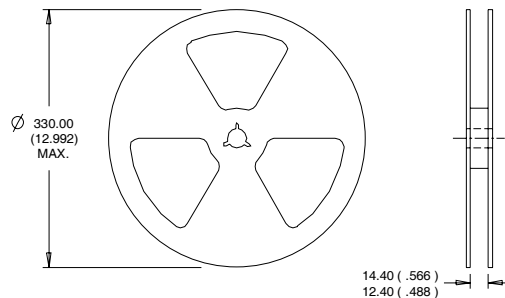
International  
**IR** Rectifier

## SO-8 Tape and Reel

Dimensions are shown in millimeters (inches)



- NOTES:
1. CONTROLLING DIMENSION : MILLIMETER.
  2. ALL DIMENSIONS ARE SHOWN IN MILLIMETERS(INCHES).
  3. OUTLINE CONFORMS TO EIA-481 & EIA-541.



- NOTES :
1. CONTROLLING DIMENSION : MILLIMETER.
  2. OUTLINE CONFORMS TO EIA-481 & EIA-541.

### Notes:

- ① Repetitive rating; pulse width limited by max. junction temperature.
- ② Starting  $T_J = 25^\circ\text{C}$ , Q1:  $L = 0.95\text{mH}$   
 $R_G = 25\Omega$ ,  $I_{AS} = 8.3\text{A}$ ; Q2:  $L = 0.54\text{mH}$   
 $R_G = 25\Omega$ ,  $I_{AS} = 9.8\text{A}$ .
- ③ Pulse width  $\leq 400\mu\text{s}$ ; duty cycle  $\leq 2\%$ .
- ④ When mounted on 1 inch square copper board.
- ⑤  $R_\theta$  is measured at  $T_J$  approximately  $90^\circ\text{C}$ .

Data and specifications subject to change without notice.  
This product has been designed and qualified for the Industrial market.  
Qualification Standards can be found on IR's Web site.

International  
**IR** Rectifier

IR WORLD HEADQUARTERS: 233 Kansas St., El Segundo, California 90245, USA Tel: (310) 252-7105  
TAC Fax: (310) 252-7903

Visit us at [www.irf.com](http://www.irf.com) for sales contact information. 04/04  
[www.irf.com](http://www.irf.com)